

Computer to Print

(T.F. se izrađuje NIP tehnikama)

Magnetografija & Ofsetni tisak

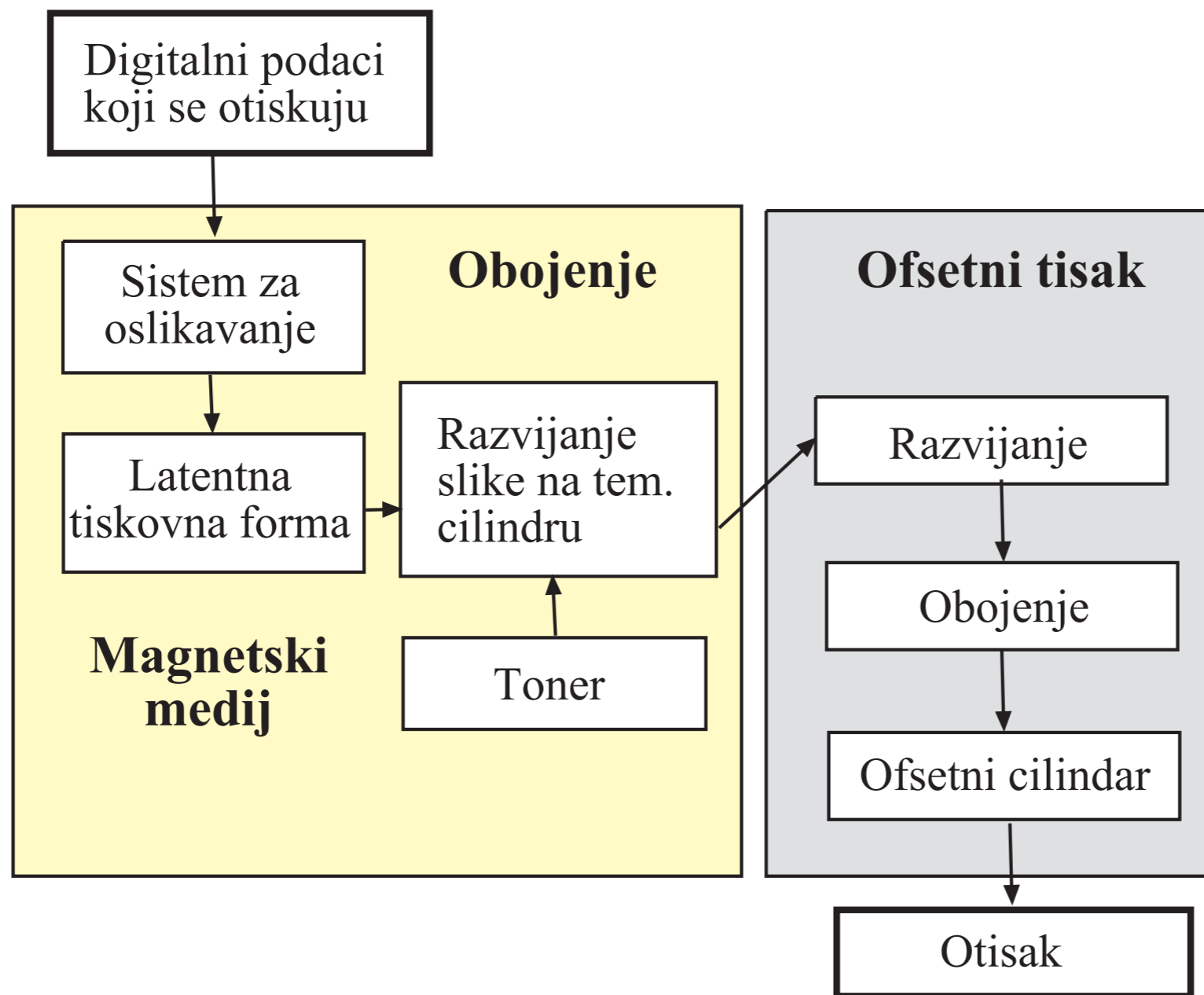

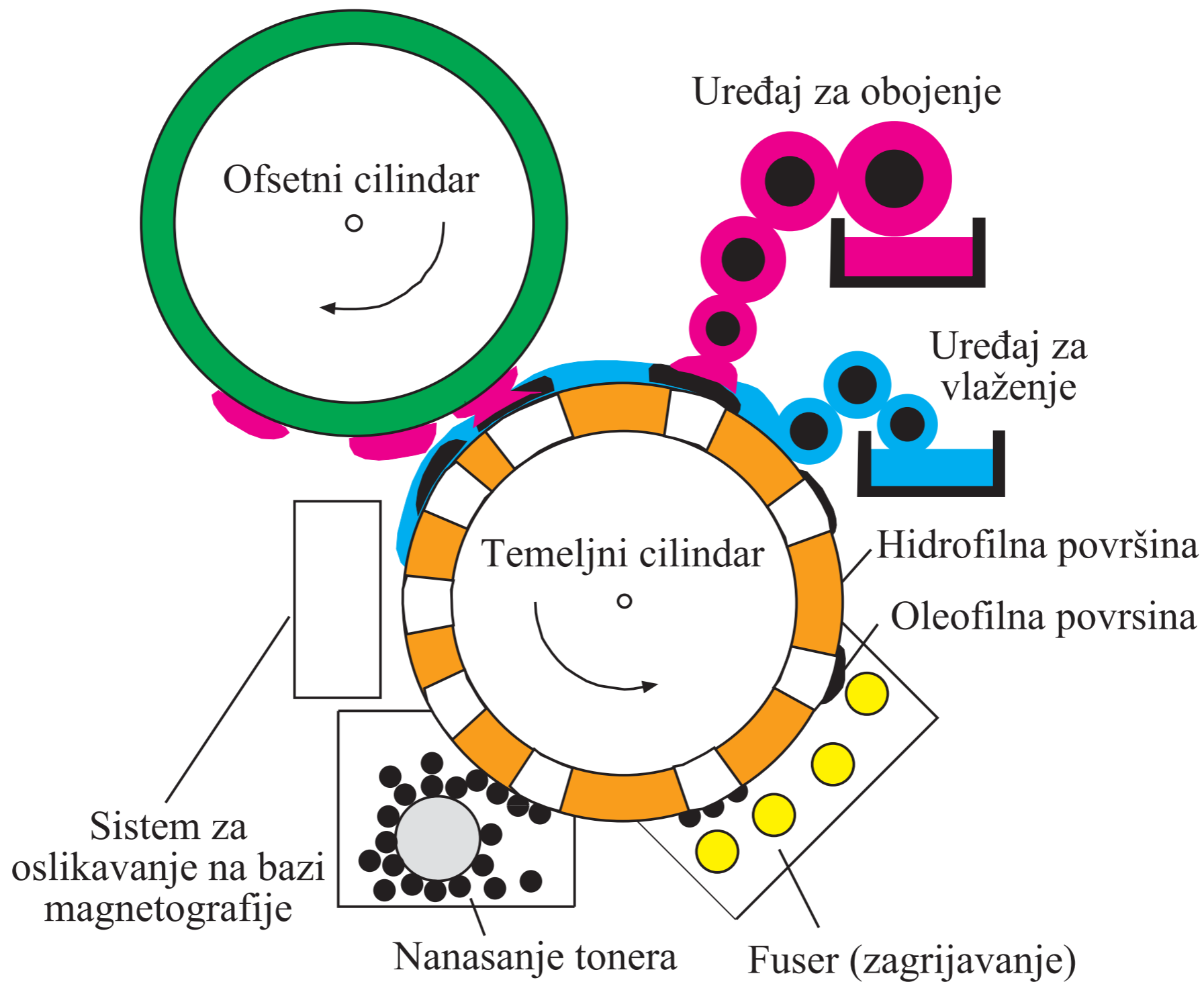

Elektrofotografija & ofsetni tisak

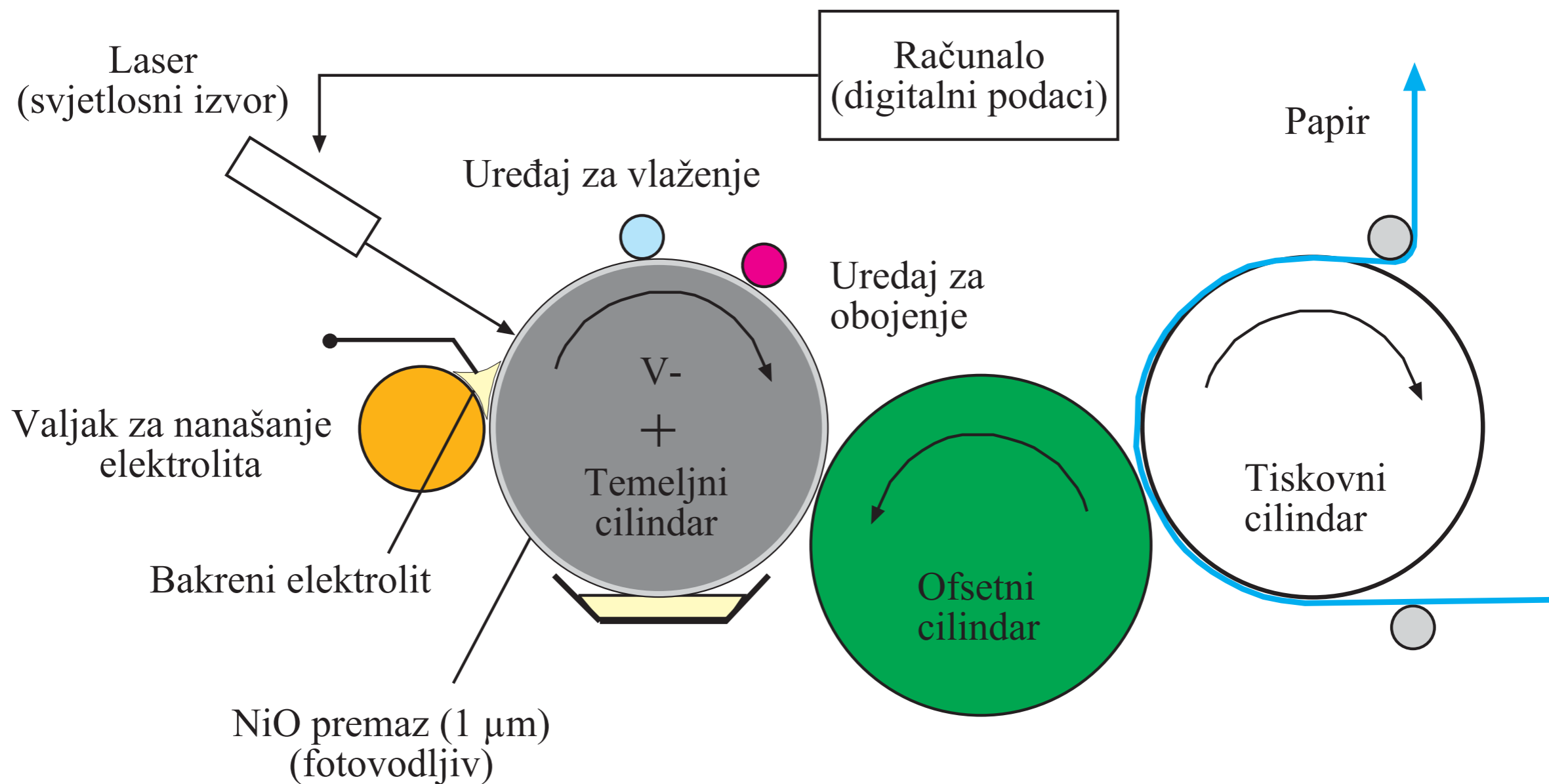

Princip generiranja tiskovne forme

Oslikavanje
(UV laser, 351 nm)

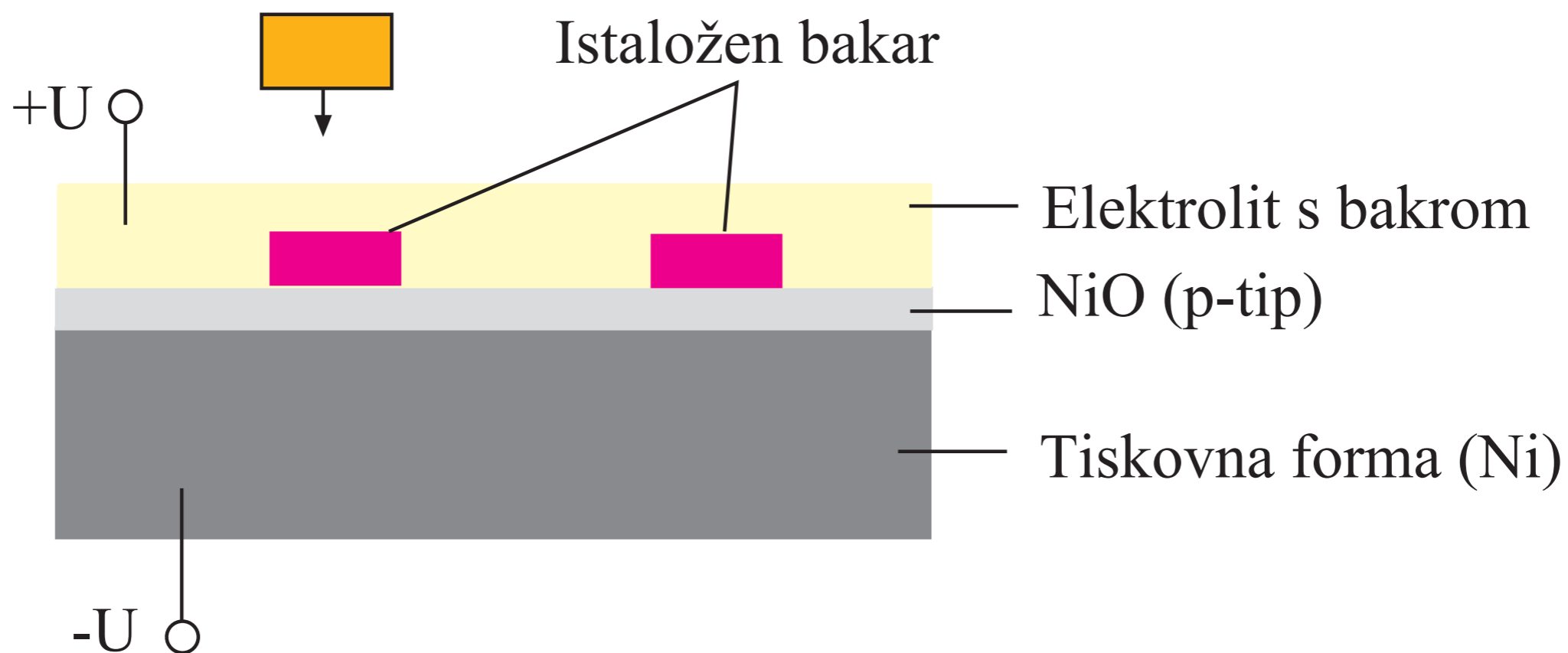

Piezo Inkjet
Kontinuirani Inkjet

Inkjet & Ofsetni tisak

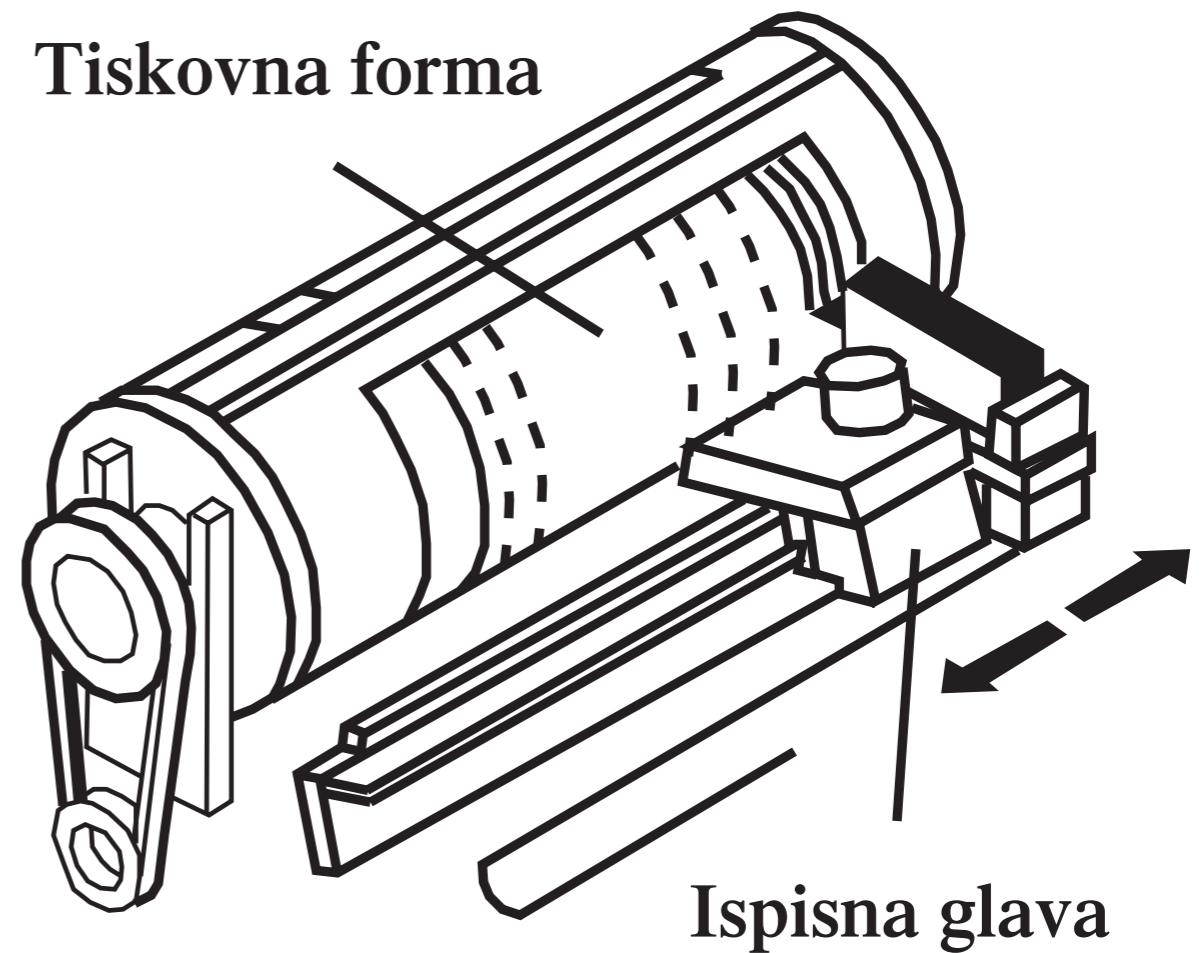
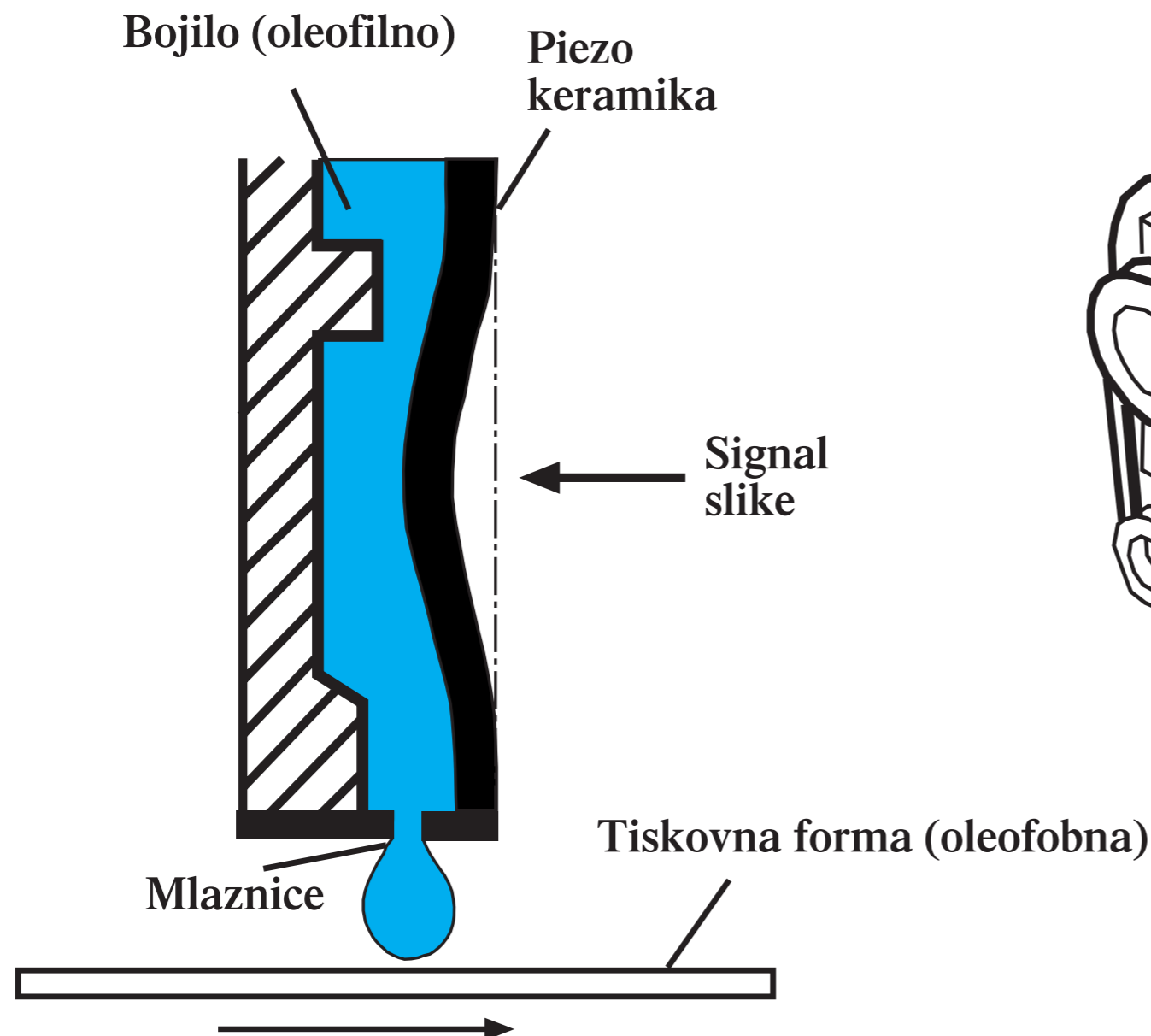

Iris (Scitex)

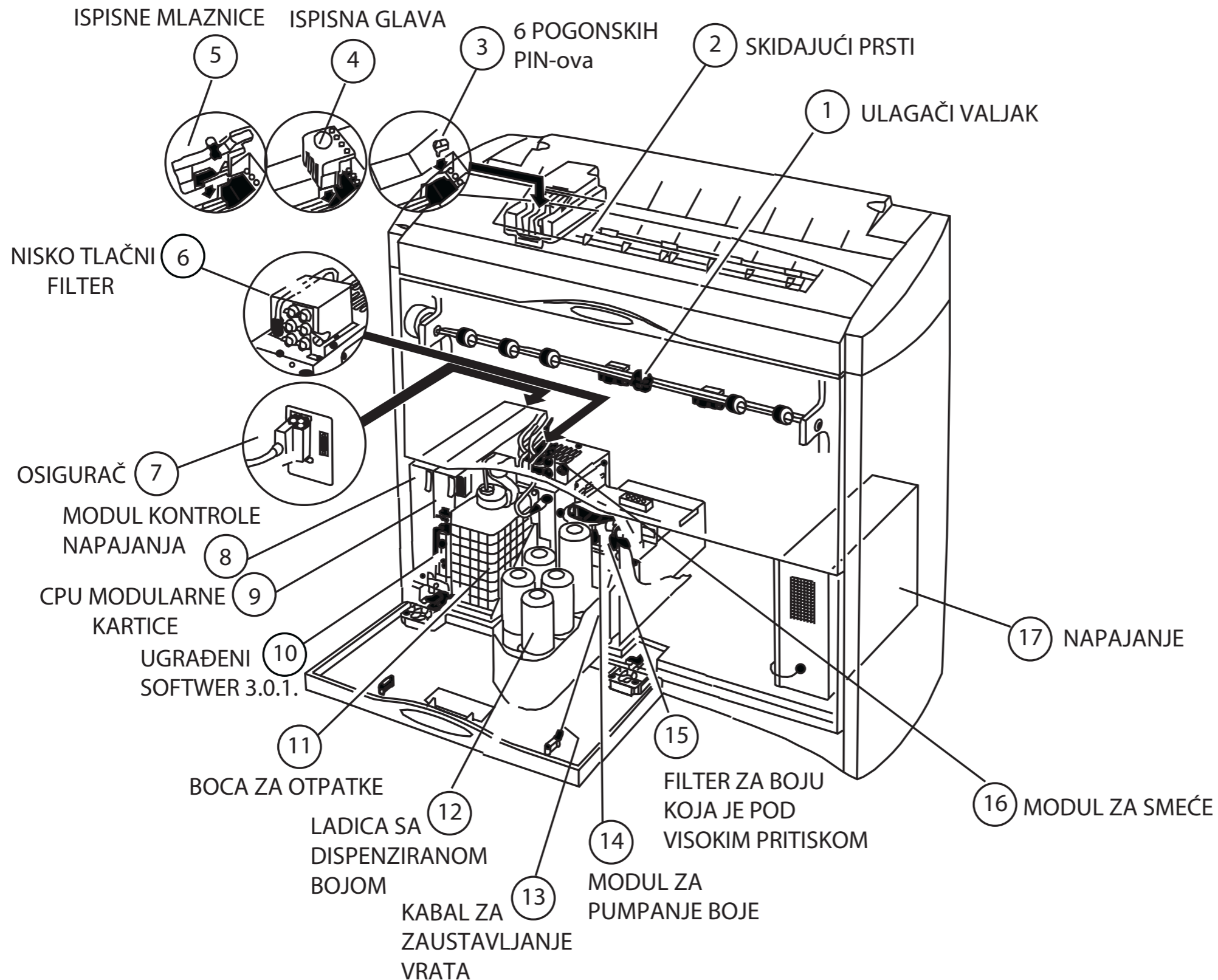

Hvala na pažnji!